

Ausführung EM/ET 233 F/  
type EM/ET 233 F

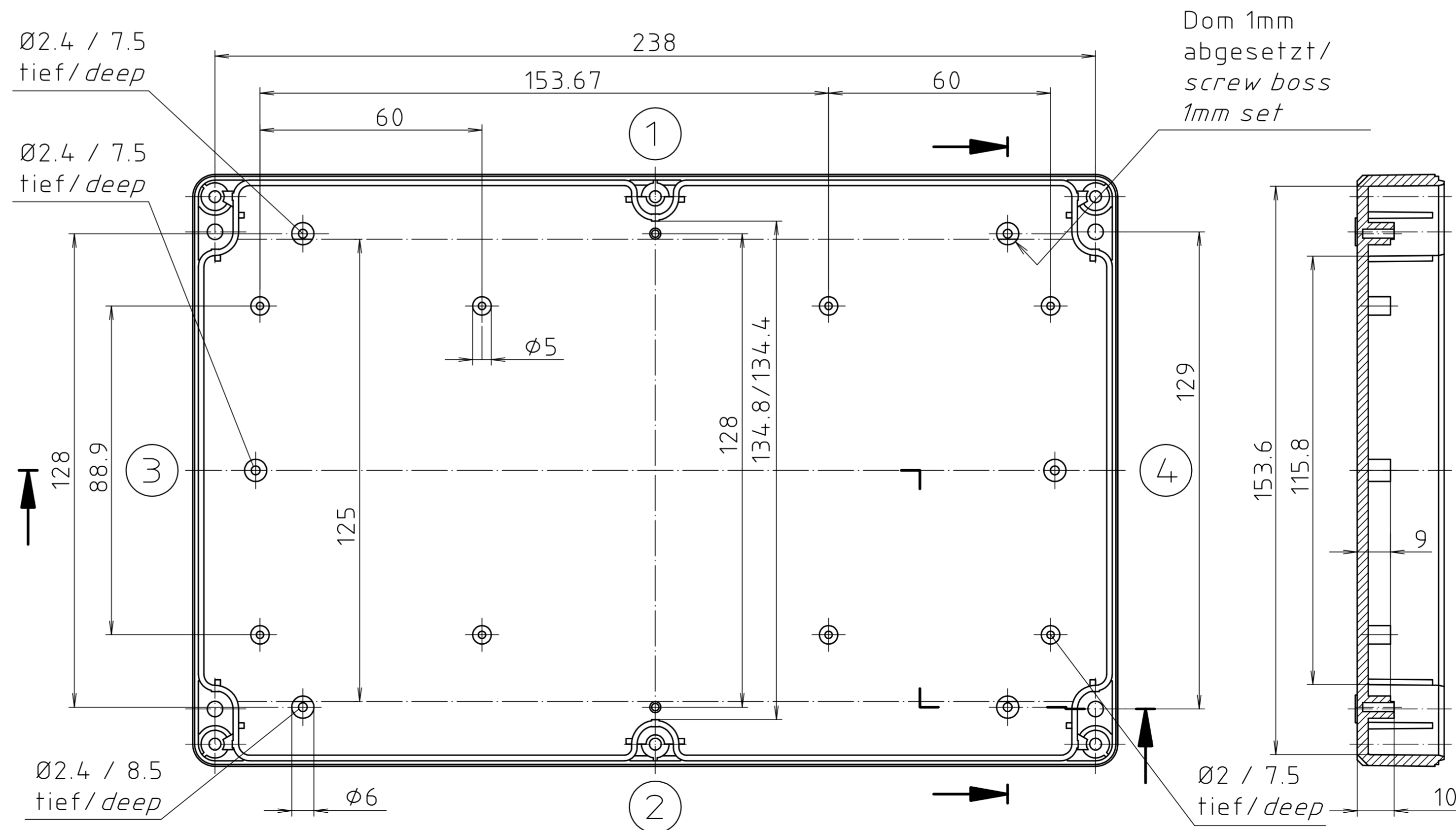

Maßstab/ Scale:	1:1
Zeichnungs-Nr. / Drawing-No.:	1K 5145.150.02
Artikel / Article:	EM/ET 233 EM/ET 233 F Katalogzeichnung / Catalogue drawing
A.Nr. / Datum / Alt.-No. / Date:	3633 / 22.08.2002
DISK:	2 501 708
Datum / Date:	24.03.99 AK

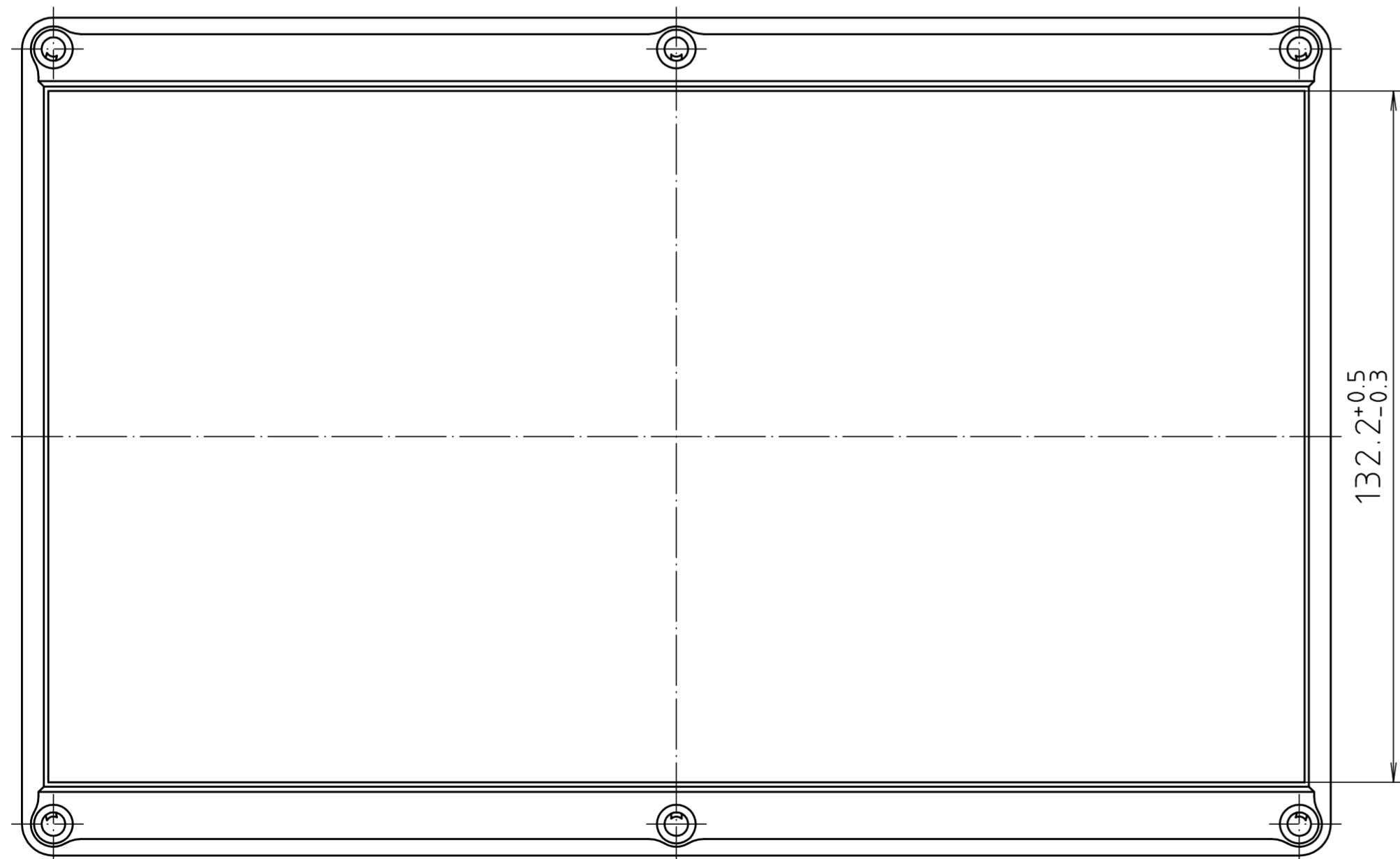
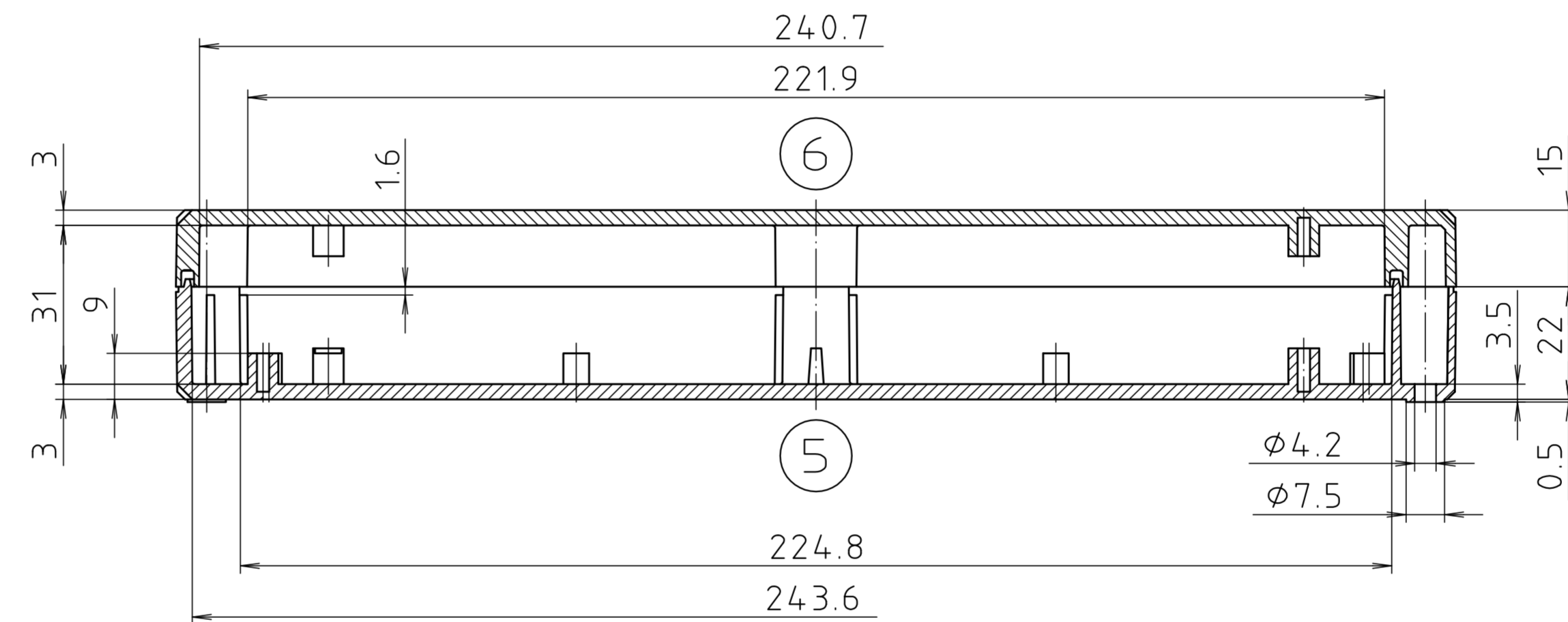
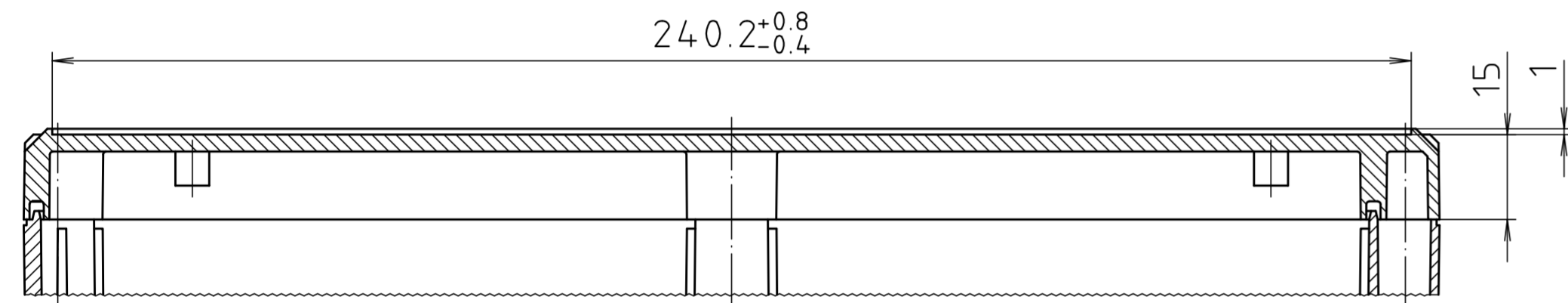
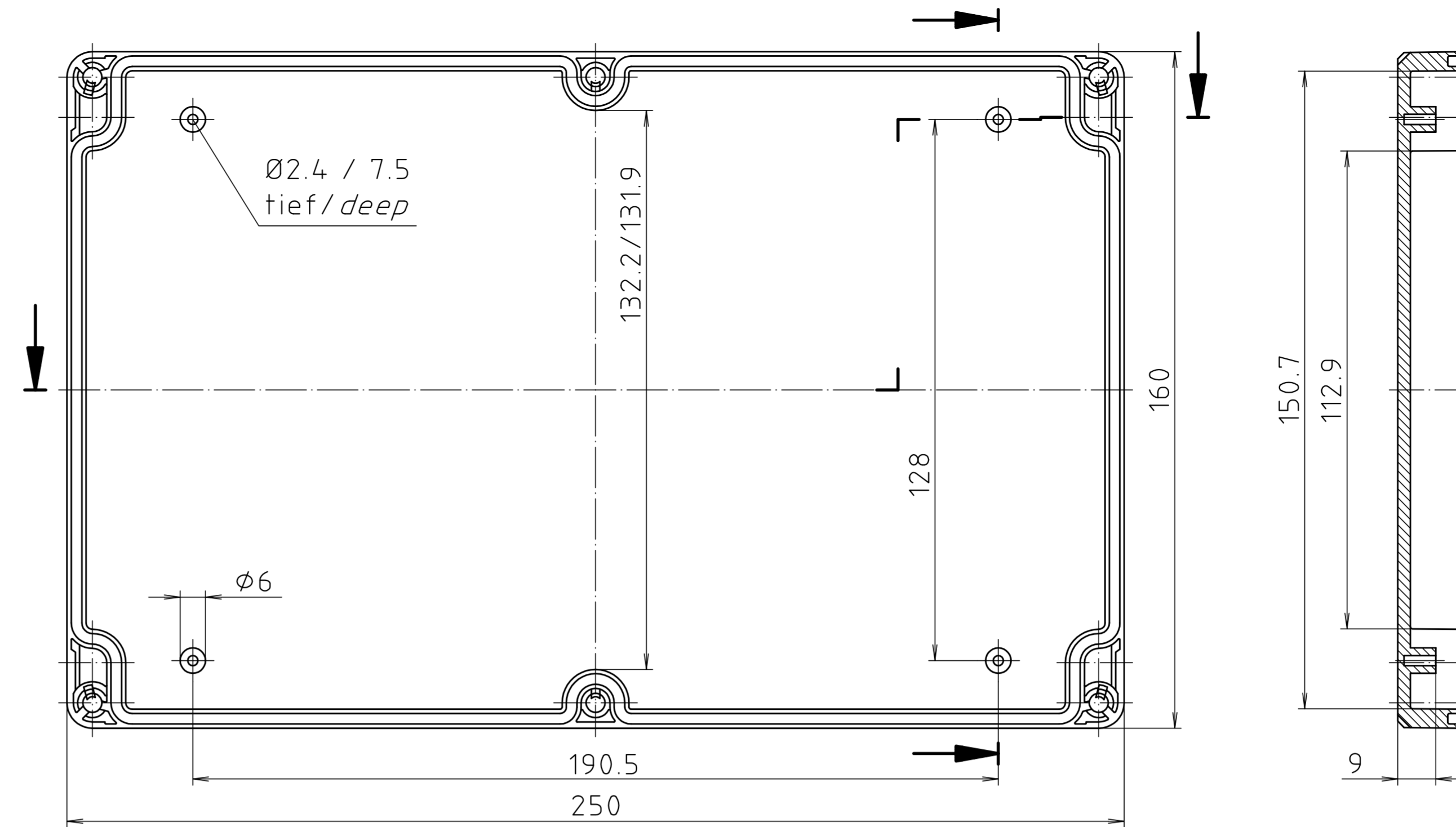