

"Schutzvermerk nach DIN ISO 16016 beachten" "Please pay attention to copyright note DIN ISO 16016"

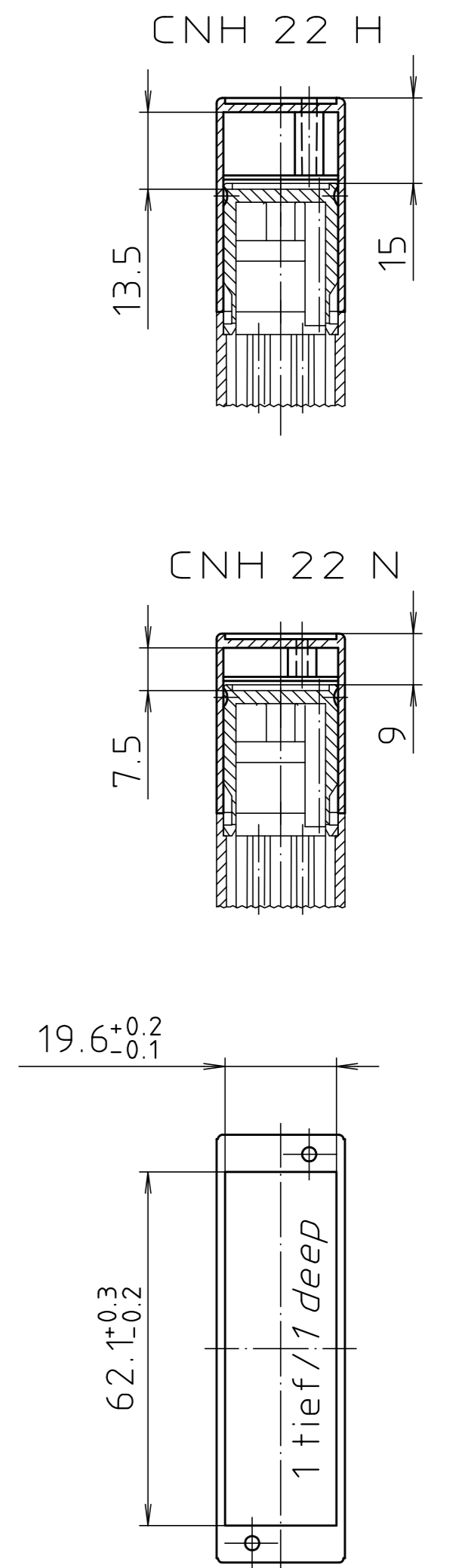

Maßstab/ Scale:	1:1	
Zeichnungs-Nr. / Drawing-No.:	2K 5180.043.04	
Artikel / Article:	CombiNorm CN(S) 22 AK	
Katalogzeichnung / Catalogue drawing		
A Nr / Alt-No.:	Datum / Date:	
3056	20.08.02	
3157	08.02.95	
3056	26.09.94	
DISK:	2 601 168	
Datum / Date:	16.03.94 HR	

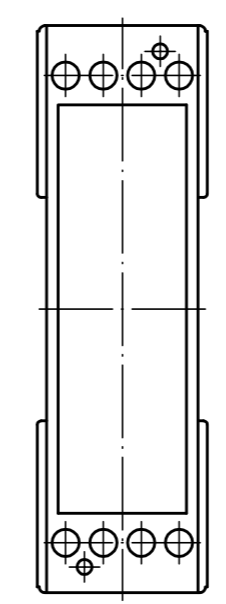
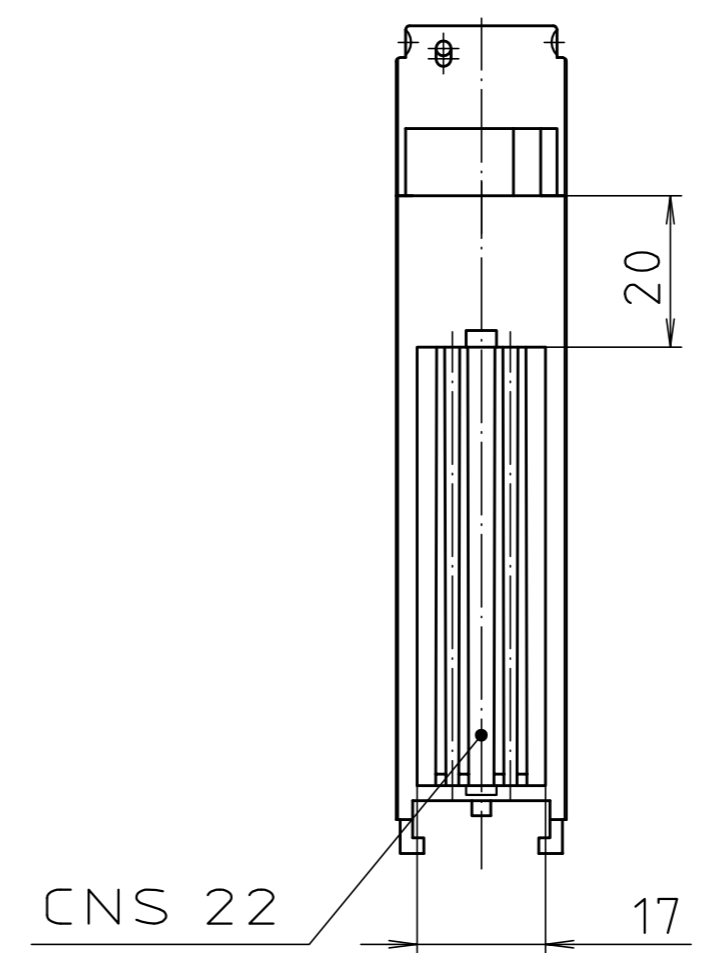
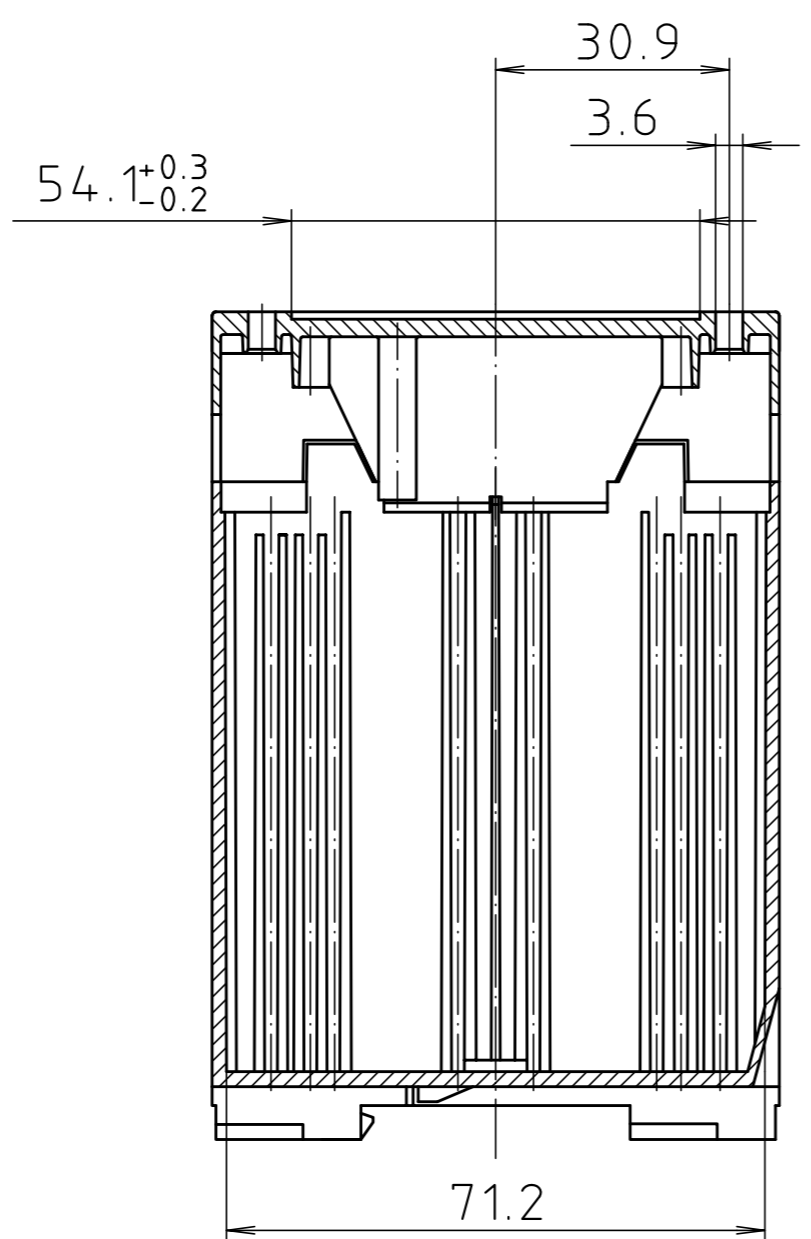
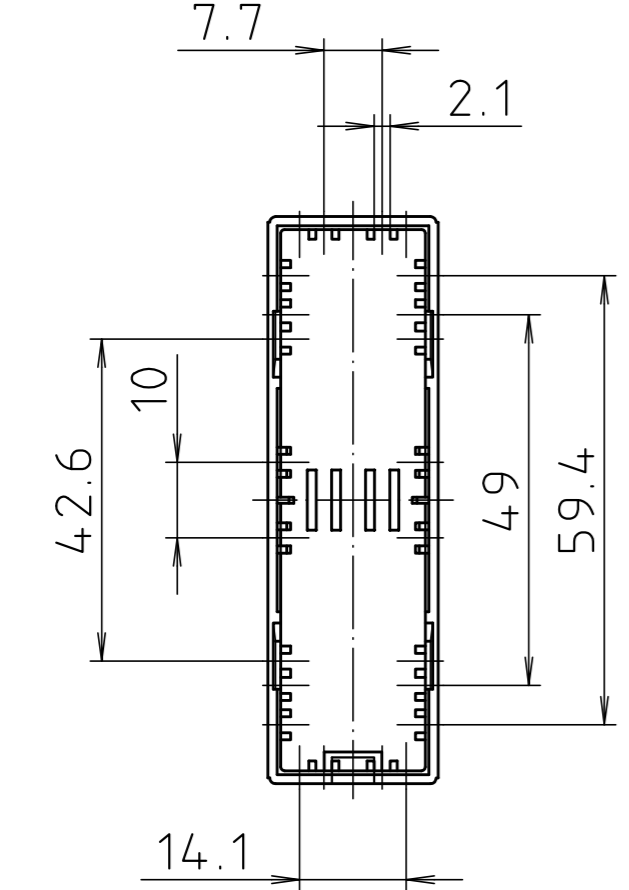
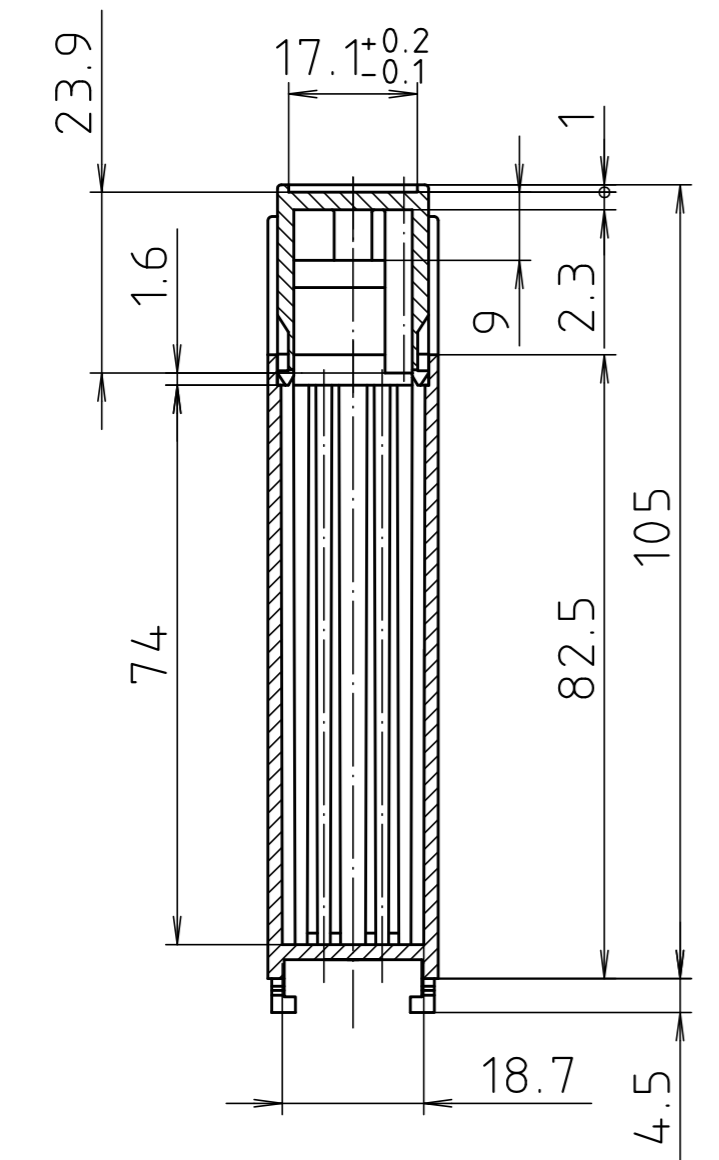
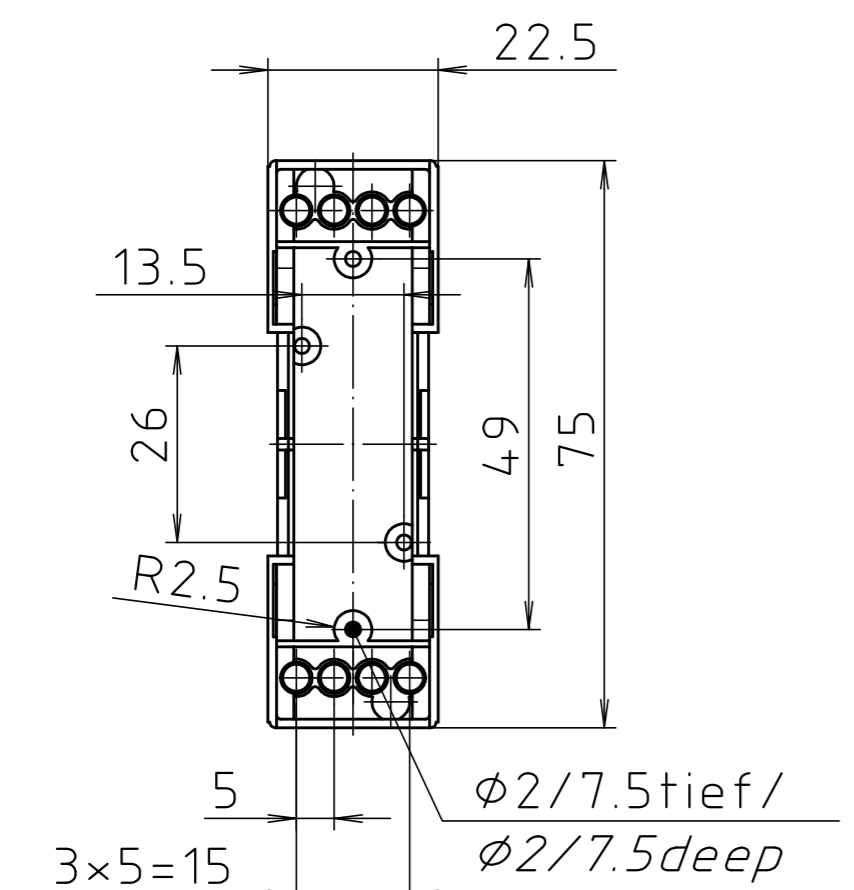