

"Schutzvermerk nach DIN ISO 16016 beachten" "Please pay attention to copyright note DIN ISO 16016"

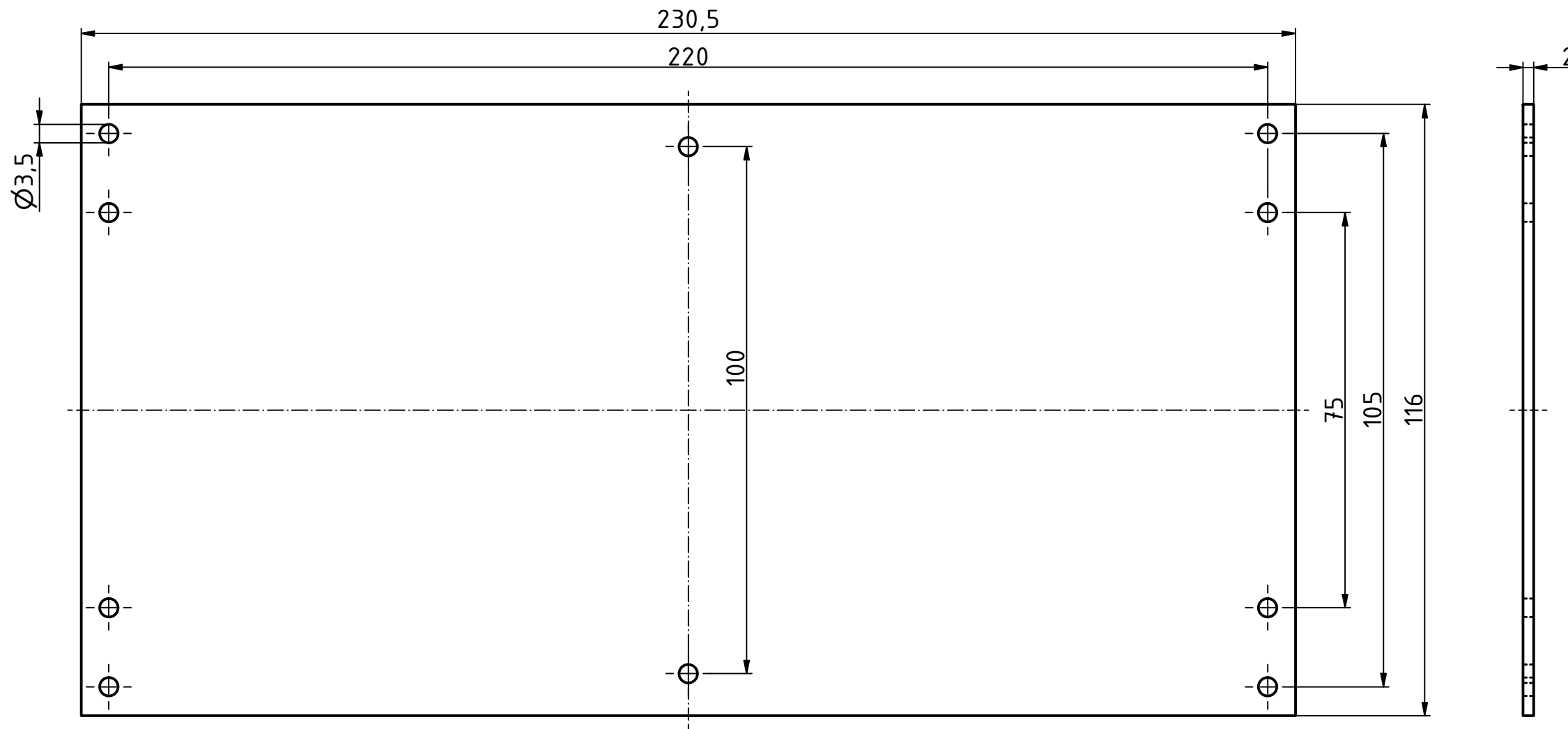

Maßstab/ Scale: 1:1		
Zeichnungs-Nr. / Drawing-No.: 3K 5390.346.01		
Artikel / Article: BOCUBE B M 2613 Katalogzg./Catalogue draw.		
Ä.Nr/ Alt.No:	Datum/ Date:	 BOPLA A Phoenix Mecano Company
DISK: 2504510.idw Datum/Date: 01.04.2021 KH		