

"Schutzvermerk nach DIN ISO 16016 beachten" "Please pay attention to copyright note DIN ISO 16016"

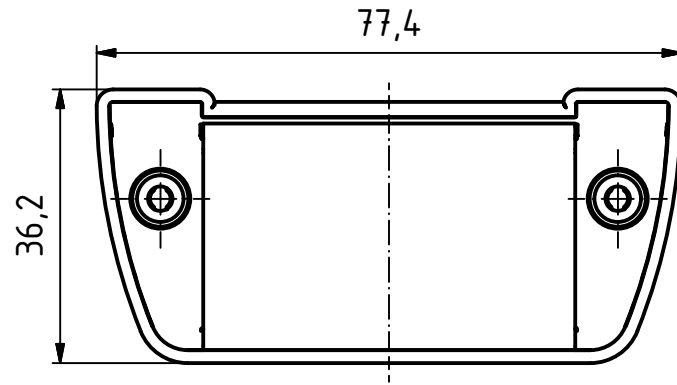

ASM 830 AL

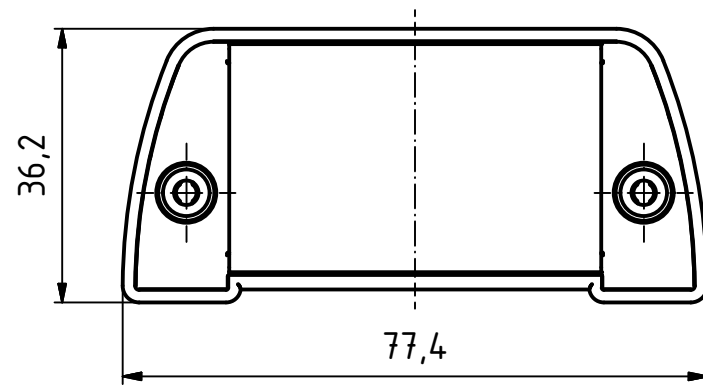
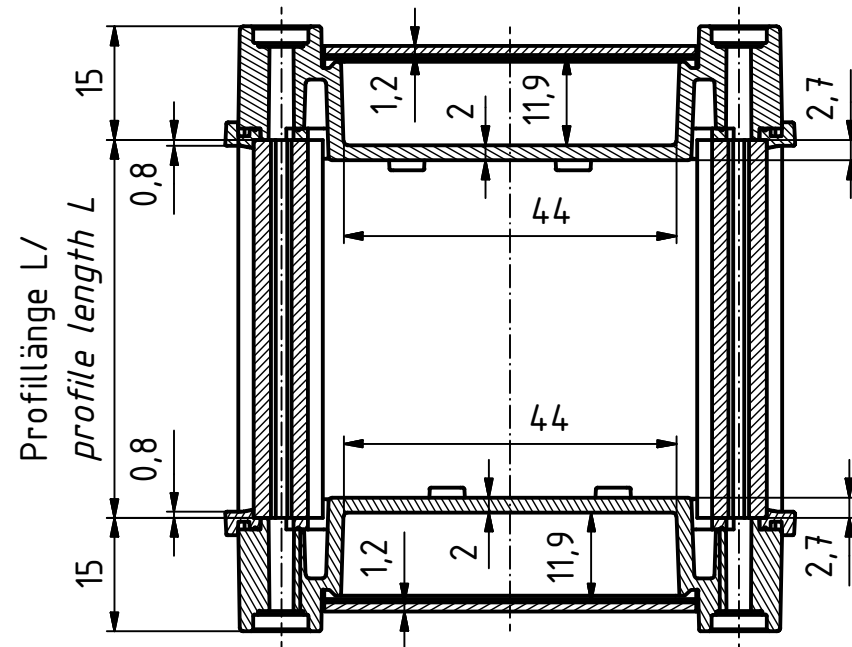
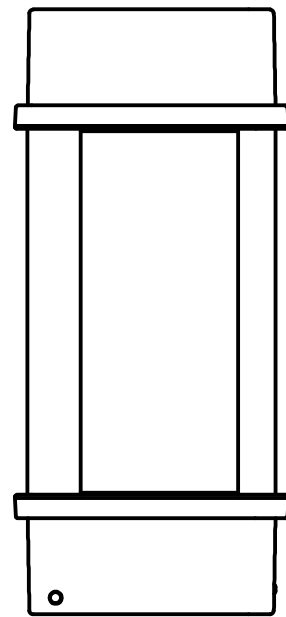
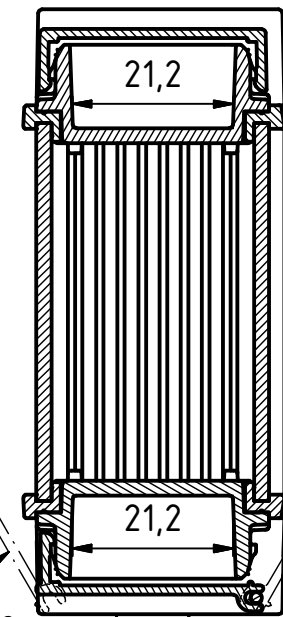

ASM 830 SAL

ASM 830 SAL1
Scharnierseite = Folienseite/
ASM 830 SAL1
hinged side = membrane side

ASM 830 SAL2
Scharnierseite = glatte Seite/
ASM 830 SAL2
hinged side = flat side

Maßstab/
Scale: 1:1

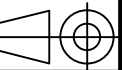

Zeichnungs-Nr. / Drawing-No.:
3K 5365.115.01

Artikel / Article:
AluStyle
ASM 830

Katalogzeichnung/Catalogue drawing

Ä.Nr/
Alt.No:

Datum/
Date:



DISK: 2802951.idw
Datum/Date: 22.04.2008 HR